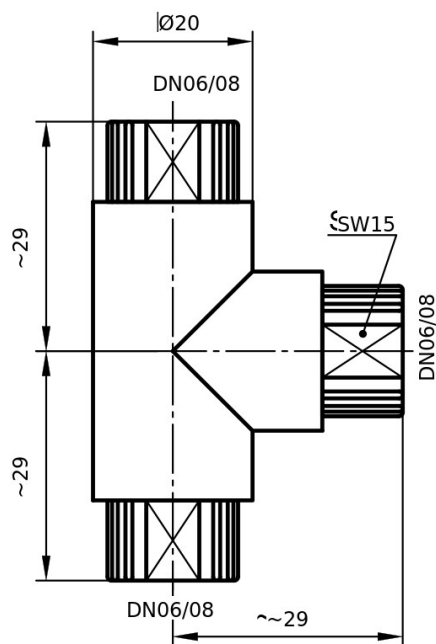

Illustration exemplary



All data in mm; Illustration exemplary

1+300T43PF

T-union with series 1+ flexible tube connection on all ends

Technical data

Connection A	DN06/08
Connection B	DN06/08
Connection C	DN06/08
Material Body	PFA
Material Pressure Screw	PFA
Pressure Stage	PN16
Max. Media Temperature	180°C

Starting from the nominal pressure rating (at 20°C), the permissible pressure reduces with increasing media temperature.